

SWITCH

cod. 9.000.012

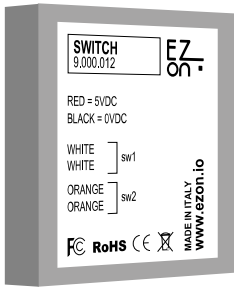

Product code: 9.000.012
 Sizes: 36 x 28 x 6mm
 Input number: 3
 Supply voltage: 5VDC (use code 9.000.033)

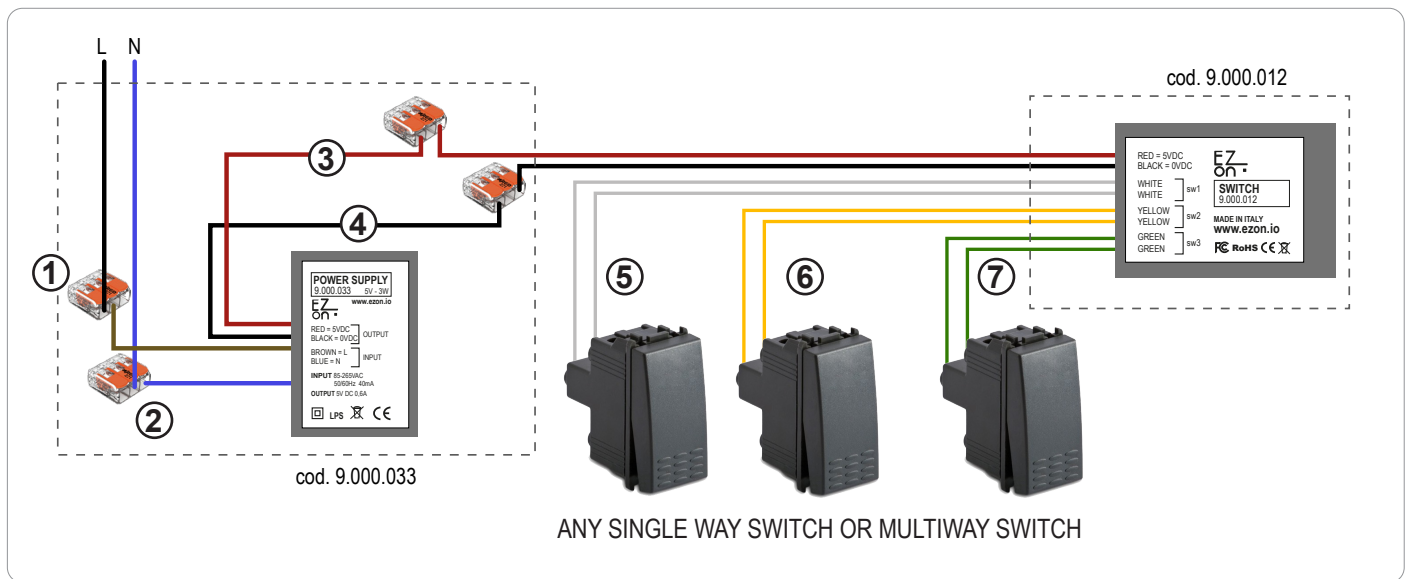

Ezon.io Switch cod. 9.000.012 requires a 5VDC power supply to function (we recommend using ezon.io power supply 9.000.033).

- Connect the phase and neutral of the power supply (brown and blue cables) to the phase (black or brown) and neutral (generally blue) of your system, thanks to the quick connectors supplied with the product 9.000.033. (points 1 and 2)
- Connect the positive (red cable) of the power supply with the positive of the switch (red cable) using the quick connector supplied with the product 9.000.033. (point 3)
- Connect the negative (black cable) of the power supply with the negative of the switch (black cable) using the quick connector supplied with the product 9.000.033. (point 4)
- Connect any switch, button, diverter or inverter using the SW1 (white cables), SW2 (yellow cables), SW3 (green cables) inputs. (points 5-6-7)

FYI. You can connect any type of switch, diverter, inverter, button, up/down to any ezon.io device that has inputs. It is not necessary to use all the inputs, if one or more inputs have not been used, isolate the cables.

Any input can be used to control any ezon.io module present in the system even if not directly connected thanks to the programming that can be done from the APP.

The ezon.io products must not be used in any way for the management of medical devices or other technical products critical to the operation of life support or life saving systems, as in the event of a malfunction they could lead to death or serious personal injury. Any use in the aforementioned systems requires explicit written permission from the CEO of Mediatech srl.

To learn more, visit www.ezon.io.

INSTALLATION INSTRUCTION AND EXAMPLES OF USE

MADE IN ITALY
www.ezon.io



SWITCH

cod. 9.000.012

The **ezon.io system** can be managed and programmed through the **ezon.io APP**, available for iOS and Android and downloadable for free from the reference store.



Add a device

- Mount the device following the instructions in this manual;
- Open the **ezon.io APP** and log in or, if you do not yet have the credentials to access, proceed with the registration.
- If there are no systems associated with your account yet, you will be asked to create a new one, alternatively select the desired one from the list;
- From the initial screen, click on the symbol  corresponding to the name of the plant.
N.B. If the system shown in the initial screen is not the one in which you wish to insert the new device, remember to modify it by clicking on the item **“Change or add facility”** in the **“Settings”** menu;
- Select **“Add a new ezon.io device”** ;
- Scan the association QR Code shown on the device. To be able to carry out this operation you must have given authorization to the phone's camera;
- Follow the instructions provided by the APP.

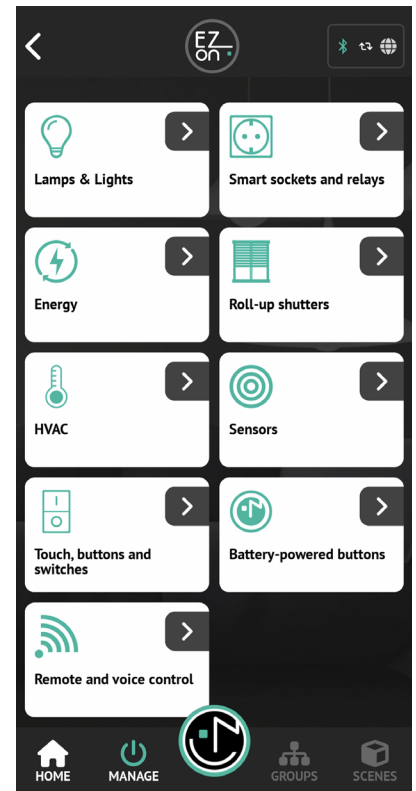
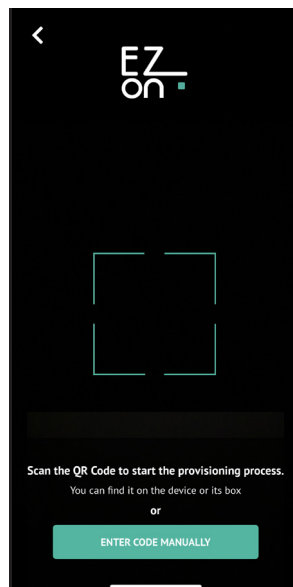
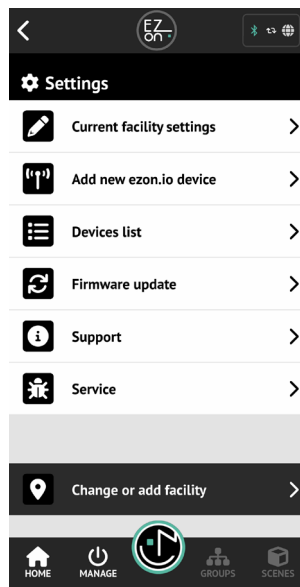
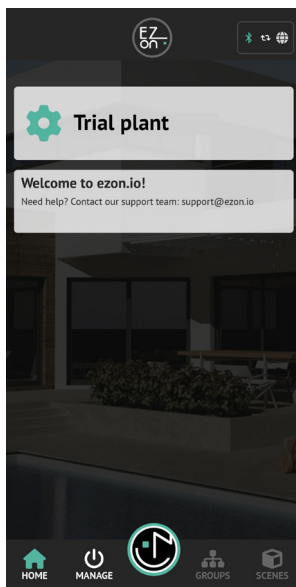

Once associated, change the settings and status of the device by clicking on **“MANAGE”**



APP INSTRUCTIONS



For further information regarding the use of the APP, refer to the online guide by framing the QR Code.

The ezon.io products must not be used in any way for the management of medical devices or other technical products critical to the operation of life support or life saving systems, as in the event of a malfunction they could lead to death or serious personal injury. Any use in the aforementioned systems requires explicit written permission from the CEO of Mediatech srl.

To learn more, visit www.ezon.io.



EXAMPLES OF USE

Lighting from three points

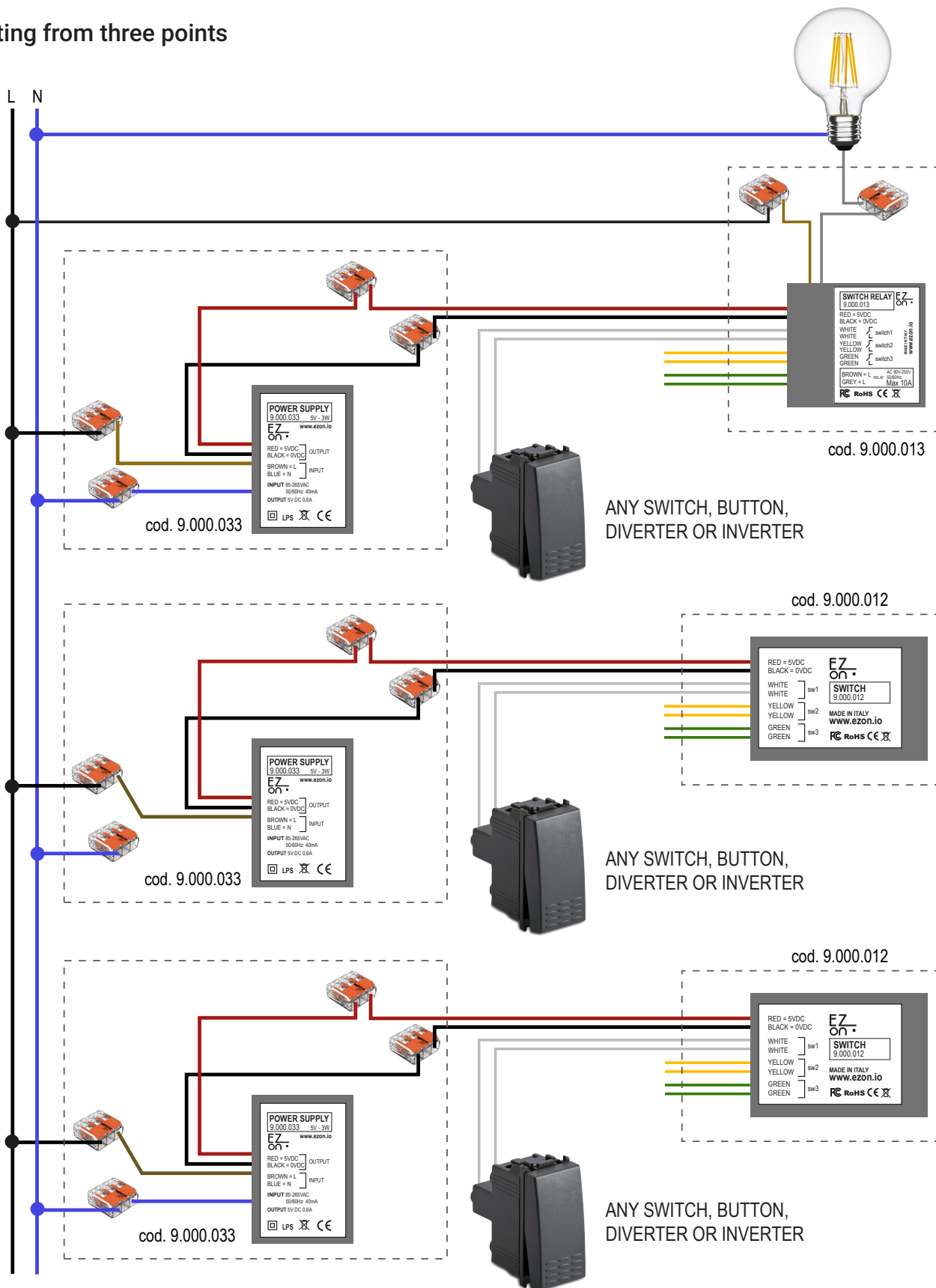

The ezon.io products must not be used in any way for the management of medical devices or other technical products critical to the operation of life support or life saving systems, as in the event of a malfunction they could lead to death or serious personal injury. Any use in the aforementioned systems requires explicit written permission from the CEO of Mediatech srl.

To learn more, visit www.ezon.io.